

 **YARD GARD®**

 **FARM GARD®**

FENCING PRODUCTS

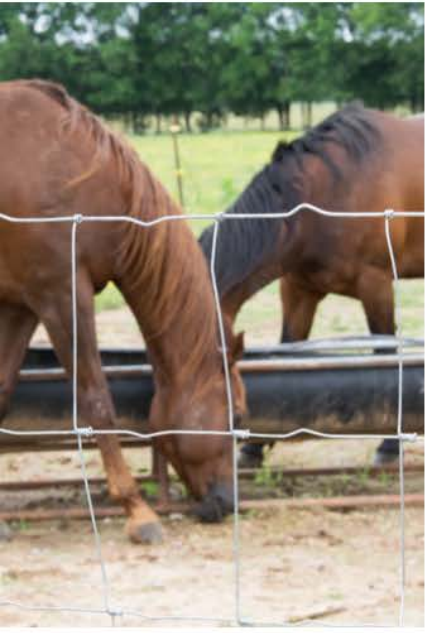

MAT®
MIDWEST AIR TECHNOLOGIES, INC.

6700 WILDLIFE WAY
LONG GROVE, IL 60047



FENCING PRODUCTS

YardGard® and FarmGard® brands of quality borders and fencing meet the needs of agricultural and residential property owners, industry and municipalities. Manufactured and distributed by Midwest Air Technologies, Inc., The YardGard® and FarmGard® products can be found at home improvement centers, mass retailers, hardware and farm supply retailers, and wholesale distributors across North America. YardGard® and FarmGard® are the brands that people trust.

For more information about our products, please call **1-800-628-8815** or visit our website at...

www.mat-holdings.com





TABLE *OF* CONTENTS

AGRICULTURAL

Field Fence	5
Horse Fence	6
High Tensile Smooth Wire	6
Electric Field Fence	7
Black Annealed Wire	7
Smooth Merchant Wire	7
Rebar TY Wire	8
Fence Stays	8
Barbed & Barbless Wire	8

FENCE POSTS & ACCESSORIES

T-Posts	10
U-Posts	11
Earth Anchors	12
Silt Fence	12
Fence Post Driver	12
Fence Post Clips	12

RESIDENTIAL WIRE FENCING

Hardware Cloth	14
Galvanized Welded Wire	15
Garden Fence (Rabbit Fence)	16
Cage Wire	16
Tomato Fence	16
PVC Welded Wire	17
Economy Fence	17
Rabbit Netting	17
Poultry Netting	18

PLASTIC FENCING

Plastic Barrier Fence	20
Plastic Snow Fence	20
Plastic Hardware Cloth	20
Plastic Poultry Netting	21
Plastic Garden Fence	21
Plastic Multi-Purpose Netting	21
Plastic Deer Block Netting	22
Plastic Deer & Bird Netting	22
Plastic Silt Fence	22

MERCHANDISERS

In-Aisle	23
P-O-P & Packaging	23



AGRICULTURAL FENCING PRODUCTS

If farms, fields and pastures could talk, they'd ask for FarmGard® branded agricultural wire fencing products by name. FarmGard® branded agricultural fencing and accessories don't just talk-the-talk, they walk-the-walk. When seeking the most effective solutions to confining and protecting livestock and property, you can trust the FarmGard® name. Products Include: FarmGard® Field Fence, Farm-Gard® Horse Fence, FarmGard® Electric Fence Wire, Galvanized Smooth Wire, Black Annealed Wire, Rebar Ty Wire, Fence Stays, and FarmGard® Barbless & Barbed Wire.



“FarmGard® branded agricultural fencing and accessories don't just talk-the-talk, they walk-the-walk.”





FIELD FENCE

FarmGard® multi-purpose Field Fence is up to the challenge of corralling livestock such as cattle, hogs, sheep, and ratites. Special expansion crimps enable this product to expand and contract with weather changes and to stretch and conform to land contours.

- Graduated height of vertical wire openings prevents animal hooves from stepping through
- Hinged wire construction adds strength and flexibility
- Galvanized zinc coating (available Class 1) for extended life¹
- 12 ½ (or 11) gauge fill wire and 10 (or 9) gauge top and bottom wire minimizes sagging
- 3 wraps on the top and bottom wire for maximum strength
- Available in 32', 39', and 47' heights - 330' length

- Meets or exceeds ASTM A116-05 standard for metallic-coated, steel-woven fence fabric
- Meets or exceeds ASTM A641 / A 641M standard for zinc-coated galvanized carbon steel wire

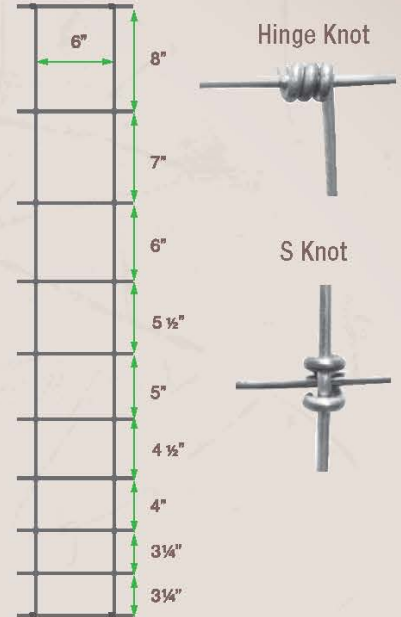

	MAT Item Number	Size	Master Pak Qty	UOM	Each Wt	Master Pak Wt	Pallet Qty	UPC Code Number
330', 11 gauge	*348124B	939 - 6 - 11	9	Roll	241.0	2169	9	0 99713 03158 6
Class 1	*348126B	1047 - 6 - 11	9	Roll	261.0	2349	9	0 99713 01909 6
330', 12½ gauge	348102B	832 - 6 - 12 ½	9	Roll	149.0	1341	9	0 99713 03111 1
Class 1	348104B	939 - 6 - 12 ½	9	Roll	170.0	1530	9	0 99713 03112 8
	348106B	1047 - 6 - 12 ½	9	Roll	194.0	1746	9	0 99713 03113 5

* Not carried in all markets. Inquire for availability.

¹ Class 1 – minimum 0.28 oz. of zinc coating per sq. ft. of surface
As defined by ASTM-A-116-05



HORSE FENCE

- Meets or exceeds ASTM A116-05 standard for metallic-coated, steel-woven fence fabric
- Meets or exceeds ASTM A641 / A 641M standard for zinc-coated galvanized carbon steel wire



FarmGard® Horse Fence is designed to safely protect and confine horses and other hoofed animals.

- Time-tested, non-climbing 2x4 in. mesh flexes to minimize the potential for leg injuries
- Fixed knot design and 12.5 gauge fill wire maintains rigidity
- Galvanized zinc coating (available Class 1) for extended life¹
- 10 gauge top and bottom wire resists sagging
- Built with pride in the U.S.
- Roll Sizes: 100 ft. in 3 thru 6 ft. heights; 200ft. rolls available in 4 ft. height only

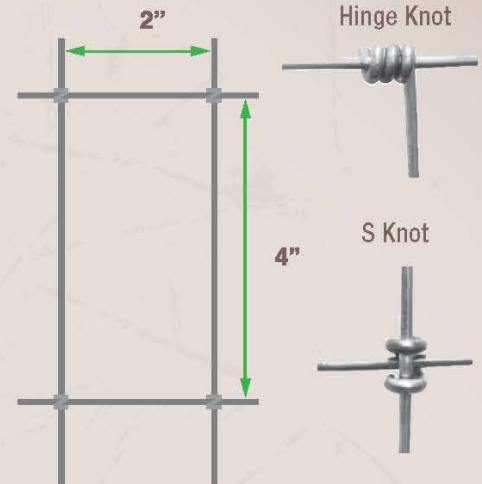

	MAT Item Number	Size	Master Pak Qty	UOM	Each Wt	Master Pak Wt	Pallet Qty	UPC Code Number
Class 1, 100'	348306B	1036 - 2 - 12 ½	8	Roll	93.0	744	8	0 99713 03116 6
	348308B	1348 - 2 - 12 ½	8	Roll	122.0	976	8	0 99713 03117 3
	348310B	1660 - 2 - 12 ½	8	Roll	151.0	1208	8	0 99713 03118 0
	348312B	1972 - 2 - 12 ½	8	Roll	180.0	1440	8	0 99713 03119 7
Class 1, 200'	348328B	1348 - 2 - 12 ½	4	Roll	244.0	976	4	0 99713 02611 7

* Not carried in all markets. Inquire for availability.

¹ Class 1 – minimum 0.28 oz. of zinc coating per sq. ft. of surface



HIGH TENSILE SMOOTH WIRE

- Meets or exceeds ASTM A 854 / A and 854 M-94 for high tensile smooth wire

MAT Item Number	Gauge	Size	Master Pak Qty	UOM	Each Wt	Master Pak Wt	Pallet Qty	UPC Code Number	Feet Per Coil
*317579A	12 ½	100# Coils	10	Coil	100.7	1007	-	0 99713 03051 0	4000
*317578A	12 ½	50# Coils	10	Coil	50.2	502	-	0 99713 03166 1	2000

- Superior strength grade vs. our standard Smooth Wire
- Used most often in agricultural applications.
- Class 3 galvanized for extended life



ELECTRIC FIELD FENCE

MAT Item Number	Gauge	Size	Master Pak Qty	UOM	Each Wt	Master Pak Wt	Pallet Qty	UPC Code Number	Feet Per Coil
317774A	14	¼ mile	2	Each	23.4	46.8	48	0 99713 00940 0	1320
317772A	14	½ mile	2	Each	45.7	91.4	48	0 99713 00939 4	2640
317754A	17	¼ mile	2	Each	11.2	22.4	120	0 99713 00914 4	1320
317752A	17	½ mile	2	Each	21.4	42.8	120	0 99713 00937 7	2640



- Ideal for rotating grazing
- For low cost fencing - permanent or temporary
- Galvanized for corrosion resistance
- Available in 14 and 17 gauge
- 1/2 and 1/4 mile length



BLACK ANNEALED WIRE

MAT Item Number	Gauge	Size	Master Pak Qty	UOM	Each Wt	Master Pak Wt	Pallet Qty	UPC Code Number	Feet Per Coil
317627A	9	10# Coils	1	Coil	10.0	10	-	0 99713 01722 1	170
317624A	12 ½	10# Coils	1	Coil	10.0	10	-	0 99713 01723 8	392
317677A	9	100# Coils	1	Coil	100.0	100	-	0 99713 01724 5	1705
317676A	10	100# Coils	1	Coil	100.0	100	-	0 99713 01725 2	2057
317675A	11	100# Coils	1	Coil	100.0	100	-	0 99713 01727 6	3924
317673A	14	100# Coils	1	Coil	100.0	100	-	0 99713 01728 3	5858
317672A	16	100# Coils	1	Coil	100.0	100	-	0 99713 01729 0	9598



- A softer, flexible wire for tying and bundling
- For use with rebar in concrete applications
- Annealing process (hot and cold treatments) makes wire less brittle and more flexible
- Non-galvanized, more economical



SMOOTH MERCHANT WIRE CLASS 3 GALVANIZED

MAT Item Number	Gauge	Size	Master Pak Qty	UOM	Each Wt	Master Pak Wt	Pallet Qty	UPC Code Number	Feet Per Coil
317527A	9	10# Coils	10	Coil	10.0	1000	-	0 99713 00943 1	170
317526A	10	10# Coils	10	Coil	10.0	1000	-	0 99713 01703 0	205
317525A	11	10# Coils	10	Coil	10.0	1000	-	0 99713 01704 7	258
317524A	12 ½	10# Coils	10	Coil	10.0	1000	-	0 99713 00942 4	392
317523A	14	10# Coils	10	Coil	10.0	1000	-	0 99713 01705 4	585
317522A	16	10# Coils	10	Coil	10.0	1000	-	0 99713 01706 1	960
317577A	9	100# Coils	1	Coil	100.0	1000	-	0 99713 01707 8	1705
317576A	10	100# Coils	1	Coil	100.0	1000	-	0 99713 01708 5	2057
317575A	11	100# Coils	1	Coil	100.0	1000	-	0 99713 01709 2	2582
317574A	12 ½	100# Coils	1	Coil	100.0	1000	-	0 99713 01710 8	3924
317573A	14	100# Coils	1	Coil	100.0	1000	-	0 99713 01711 5	5858
317572A	16	100# Coils	1	Coil	100.0	1000	-	0 99713 01712 2	9598



- Multi-use single strand wire
- Ideal for tying, fastening, hanging and bundling
- Use for shed, shop, home and farm applications
- Class 3 galvanized for high resistance to rust/corrosion
- Non-annealed
- 10 lb. and 100 lb. coils

* Not carried in all markets. Inquire for availability.



REBAR TY WIRE

MAT Item Number	Size	Master Pak Qty	UOM	Each Wt	Master Pak Wt	Pallet Qty	UPC Code Number
901130A	3.5# Coils	10	Roll	3.6	36	48	0 99713 00938 7



- Made from softer, more flexible annealed wire
- Easy to twist
- For use with rebar in concrete applications
- 3.5 lb. coils packaged ten per carton



FENCE STAYS

MAT Item Number	Size	Master Pak Qty	UOM	Each Wt	Master Pak Wt	Pallet Qty	UPC Code Number
901083A	36"	100	Each	0.34	34	3600	0 99713 91083 6
901084A	42"	100	Each	0.38	38	3600	0 99713 91084 3
901085A	48"	100	Each	0.42	42	3600	0 99713 91085 0



- Keeps barbed wire fence evenly spaced
- Galvanized for corrosion resistance
- Reduces the necessity of fence posts; Lowers costs
- 100 fence stays per pack



BARBED & BARBLESS WIRE

FarmGard® two and four point barbed wire is an economical solution to a variety of containment needs or to discourage unauthorized entry. Our barbless wire is also a multi-purpose, economical option for the confinement of thinner skinned animals or where barbed wire is prohibited.

BARBED

- Sharp two- or four-point barb options spaced every five inches
- Heavy-duty metal carrier for safe, convenient transport. Designed for easy unrolling
- Two options: Class 1, 12.5 gauge and Class 3, 15.5 gauge
- Use fence stays to keep barbed wire neat and evenly spaced
- Use with chain link or other fencing barriers for heightened security
- Available in 1,320 ft. rolls

BARBLESS

- Ideal for horses or locations where barbed wire is banned
- Made from Class 1 galvanized, 12.5 gauge double strand smooth wire that can be electrified
- Available in 1,320 ft. rolls and stored on a metal carrier for convenient transport, storage and unrolling

• Meets or exceeds ASTM A116-05 standard for metallic-coated, steel-woven fence fabric
 • Meets or exceeds ASTM A641 / A 641M standard for zinc-coated galvanized carbon steel wire

	MAT Item Number	Size	Master Pak Qty	UOM	Each Wt	Master Pak Wt	Pallet Qty	UPC Code Number
12.5 gauge	317821A	2pt, 5" Spacing	27	Reel	69.5	1876.5	27	0 99713 01713 9
Class 1	317831A	4pt, 5" Spacing	27	Reel	79.6	2149.2	27	0 99713 01714 6
	317801A	Barbless Cable	36	Reel	62.9	2264.4	36	0 99713 01716 0
15.5 gauge, Hi-Tensile	317871A	2pt, 5" Spacing	48	Reel	42.0	2016.0	48	0 99713 01778 8
Class 3	317881A	4pt, 5" Spacing	48	Reel	45.0	2160.0	48	0 99713 01715 3





FENCE POSTS AND ACCESSORIES

In addition to our large assortment of agricultural wire fencing, Midwest Air Technologies, Inc. manufactures a compatible line of posts to finish your job. With years of proven know-how, nobody understands your accessory needs better than FarmGard®. Nobody!

Products Include: T-Posts, U-Posts, Earth Anchors, Silt Fence, Fence Post Drivers, and Fence Post Clips.

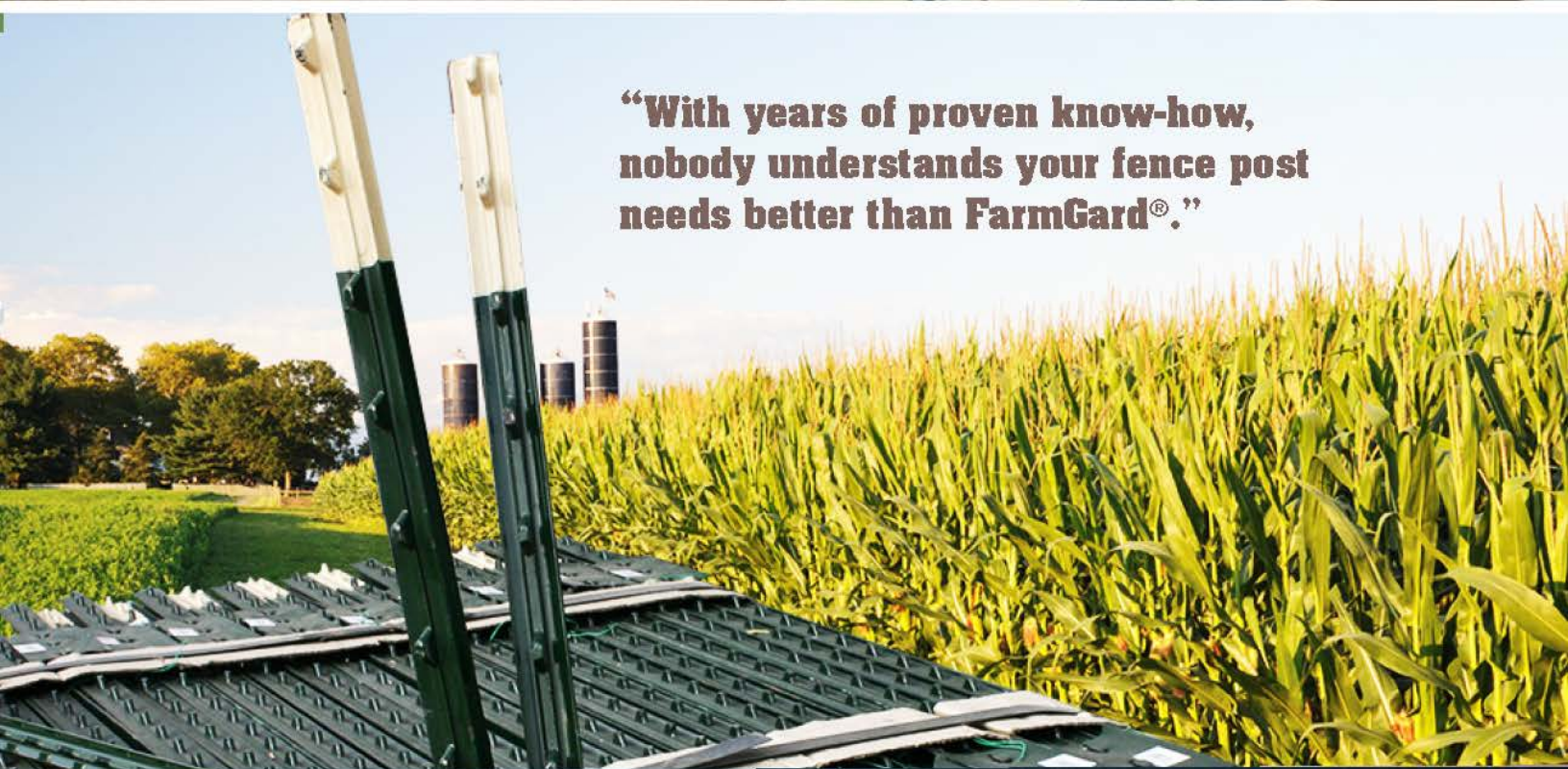

**“With years of proven know-how,
nobody understands your fence post
needs better than FarmGard®.”**



FENCE POSTS T-POSTS

Our T-Posts rate among the highest quality sold in the U.S. and provide excellent performance and service for residential, farm, industrial, and commercial applications.

- Two coats of protective enamel with exclusive prime coat finish for maximum rust protection
- Manufactured for superior strength
- Beige top signifies FarmGard® quality and provides better night visibility†
- Studded design adds strength to post, secures fence fabric and prevents slippage of T-Post clips and insulators
- Rugged, tight welded anchor plate minimizes sideways or rotational movement

- Our posts far exceed the ASTM A702A spec which requires a minimum tensile of 80,000 PSI
- Elongation levels are well within the ASTM A702 spec for acceptability and performance
- Hardness far exceeds the ASTM A702 standard
- Yield strength is well above the ASTM standard
- No signs of "Red Rust" are visible at 100 hours of salt spray exposure



	MAT Item Number	Size	Master Pak Qty	UOM	Each Wt	Master Pak Wt	Pallet Qty	UPC Code Number
Light Weight, Bundled, 0.96lbs./ft.	*901185AB	5'	200	Each	5.3	1060	200	0 99713 02188 4
	*901186AB	5 ½'	200	Each	5.8	1160	200	0 99713 02189 1
	*901187AB	6'	200	Each	6.2	1240	200	0 99713 02190 7
	*901188AB	6 ½'	200	Each	6.7	1340	200	0 99713 02191 4
	*901189AB	7'	200	Each	7.2	1440	200	0 99713 02192 1
Medium Weight, Bundled, 1.25lbs./ft.	901174AB	5'	200	Each	6.4	1280	200	0 99713 91174 1
	901175AB	5 ½'	200	Each	6.9	1380	200	0 99713 91175 8
	901176AB	6'	200	Each	7.5	1500	200	0 99713 91176 5
	901178AB	6 ½'	200	Each	8.5	1700	200	0 99713 91178 9
	901177AB	7'	200	Each	8.7	1740	200	0 99713 91177 2
	*901181AB	7 ½'	200	Each	9.5	1900	200	0 99713 03163 0
	901180AB	8'	200	Each	10.1	2020	200	0 99713 91180 2
Heavy Weight, Bundled, 1.33lbs./ft.	*901172A	10' 2"	200	Each	14.1	2820	200	0 99713 91172 7

† 2 Beige color application is registered in the U.S. Patent and Trademark Office
 * Not carried on all markets. Inquire for availability.



FENCE POSTS U-POSTS

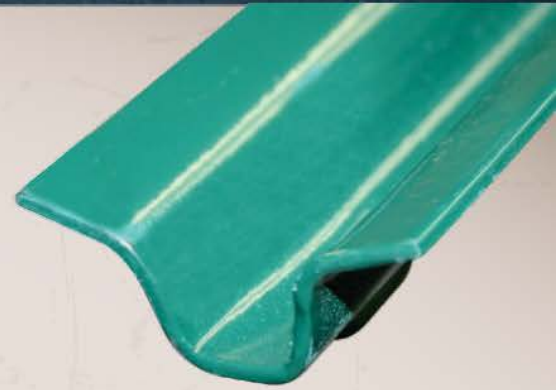

- For garden, light farm and residential use
- Powder coated steel finish
- U-channel construction provides maximum strength along with riveted anchor plate
- Notched design for securing fence to post
- Designed with a riveted or welded anchor plate to minimize lateral movement
- Use with fence post driver to pound into ground
- Suggested spacing of 5 to 10 ft. depending on fence type
- Can be used to post warning signs

	MAT Item Number	Size	Master Pak QTY	UOM	Each Wt	Master Pak Wt	Pallet Qty	UPC Code Number
Lite Duty, 14 gauge	901153A	3'	150	Each	1.5	225	150	0 99713 91153 6
	901154A	4'	150	Each	1.9	285	150	0 99713 91154 3
	901155A	5'	150	Each	2.3	345	150	0 99713 91155 0
	901150A	6'	150	Each	2.7	405	150	0 99713 91150 5
Heavy Duty, 13 gauge	901158A	5'	150	Each	4.7	705	150	0 99713 91158 1
	901156A	6'	150	Each	5.5	825	150	0 99713 91156 7
	901157A	7'	150	Each	6.4	960	150	0 99713 91157 4



EARTH ANCHORS

MAT Item Number	Size	Master Pak Qty	UOM	Each Wt	Master Pak Wt	Pallet Qty	UPC Code Number
901111A	3" x 15"	10	Ea	1.6	16	1170	0 99713 91111 6
901113A	3" x 30"	10	Ea	2.7	27	560	0 99713 91113 0
901114A	4" x 40"	10	Ea	3.6	36	330	0 99713 91114 7
901018A	6" x 48"	10	Ea	8.3	83	200	0 99713 91018 8

- Welded base screw self digs into all types of soil
- Use to secure, tie down or rope-off area
- Easy installation - Twist auger into ground and tie off to eyelet



SILT FENCE

MAT Item Number	Size	Master Pak Qty	UOM	Each Wt	Master Pak Wt	Pallet Qty	UPC Code Number
883121A	2' x 100'	1	Roll	24.0	24	25	0 99713 00944 8
883131A	3' x 100'	1	Roll	25.2	25	25	0 99713 00945 5

- Economical yet effective in controlling runoff sediment
- Installs quickly and easily
- UV resistant filter fabric is recyclable
- Contractor grade
- Strong and flexible



FENCE POST DRIVER

MAT Item Number	Size	Master Pak Qty	UOM	Each Wt	Master Pak Wt	Pallet Qty	UPC Code Number
901147A	23 1/2" x 9" x 3"	2	Ea	17.1	34	128	0 99713 03200 2

- Designed to minimize damage to fence post tops
- Eases work by driving fence with 17lbs of force
- Handles are tapered for comfortable hand placement
- 23 1/2" length with weighted and reinforced steel head
- Inside driver diameter - 2 7/8 in.



FENCE POST CLIPS FOR T-POSTS

MAT Item Number	Size	Master Pak Qty	UOM	Each Wt	Master Pak Wt	Pallet Qty	UPC Code Number
901169B	-	40	Bag	0.5	20	N/A	0 99713 03200 2

- Holds strong through tough weather conditions
- 25 clips per bag
- Easy installation





RESIDENTIAL FENCING PRODUCTS

Along with our agricultural fencing applications, YardGard® has a history of innovative residential fencing solutions. YardGard® has been anticipating the needs of the residential fencing marketplace for longer than anyone. Products Include: Hardware Cloth, Welded Wire, Garden Fence, Economy Fence, Poultry Netting and Rabbit Netting under the registered name YardGard®; and Tomato Fence under the TomatoGard® name.



“YardGard® has been anticipating the needs of the residential fencing marketplace for longer than anyone.”



YARD GARD® HARDWARE CLOTH

- Ideal for screen doors, gutter guards, animal control, cages, tree guards, gardening applications, craft projects and more
- Lightweight, flexible and economical
- Double zinc coated for maximum rust resistance
- Available in three gauges: 19, 23, and 27
- Choose PVC color option for a more environmentally pleasing appearance and additional weather protection

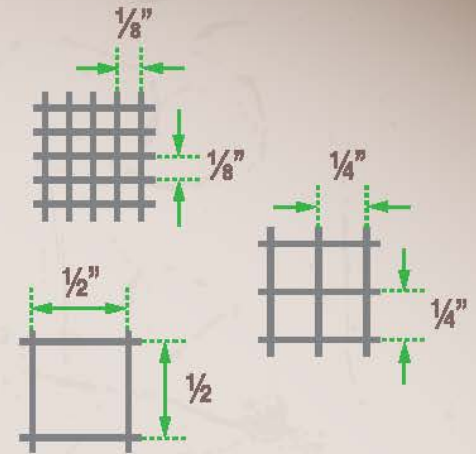

	MAT Item Number	Size	Master Pak Qty	UOM	Each Wt	Master Pak Wt	Pallet Qty	UPC Code Number
Galvanized, 27 gauge, 1/8" Mesh	308182B	24" x 100"	1	Roll	25.3	25.3	36	0 9971303265 1
	308183B	36" x 100"	1	Roll	37.9	37.9	36	0 9971303266 8
Galvanized, 23 gauge, 1/4" Mesh	308231B	24" x 5"	12	Roll	1.3	15.3	432	0 99713 03182 1
	308232B	36" x 5"	12	Roll	2.0	23.8	288	0 9971303183 8
	308234B	4 8" x 5"	12	Roll	2.6	31.7	240	0 99713 03185 2
	308235B	24" x 10"	12	Roll	2.6	31.7	360	0 9971303186 9
	308237B	36" x 10"	12	Roll	6.0	48.7	240	0 9971303188 3
	308240B	48" x 10"	12	Roll	5.3	63.5	180	0 9971303191 3
	308212B	24" x 25"	4	Roll	6.5	25.5	120	0 9971303171 5
	308233B	36" x 25"	4	Roll	10.4	41.8	100	0 9971303184 5
	308236B	48" x 25"	4	Roll	13.9	55.8	48	0 9971303187 6
	308247B	24" x 50"	1	Roll	13.9	13.9	42	0 9971303192 0
	308238B	36" x 50"	1	Roll	20.9	20.9	42	0 9971303189 0
	308239B	48" x 50"	1	Roll	27.9	27.9	42	0 9971303190 6
	308245B	24" x 100"	1	Roll	27.9	27.9	20	0 9971303271 2
	308249B	30" x 100"	1	Roll	34.9	34.9	20	0 9971303275 0
	308241B	36" x 100"	1	Roll	42.0	42.0	20	0 9971303267 5
	308242B	48" x 100"	1	Roll	55.8	55.8	20	0 9971303268 2
Galvanized, 19 gauge, 1/2" Mesh	308221B	24" x 5"	12	Roll	1.7	20.9	360	0 9971303172 2
	308222B	36" x 5"	12	Roll	2.6	31.5	240	0 9971303173 9
	308223B	48" x 5"	12	Roll	3.7	44.2	192	0 9971303174 6
	308224B	24" x 25"	4	Roll	8.7	34.6	96	0 9971303175 3
	308225B	36" x 25"	4	Roll	12.6	50.3	64	0 9971303176 0
	308226B	48" x 25"	4	Roll	17.0	67.9	48	0 9971303177 7
	308227B	24" x 10"	12	Roll	3.6	42.8	288	0 9971303178 4
	308228B	36" x 10"	12	Roll	5.5	66.1	192	0 9971303179 1
	308230B	48" x 10"	12	Roll	7.3	88.1	144	0 9971303181 4
	308199B	24" x 50"	1	Roll	17.6	17.6	30	0 9971303169 2
	308200B	36" x 50"	1	Roll	27.6	27.6	30	0 9971303170 8
	308229B	48" x 50"	1	Roll	40.9	40.9	30	0 99713 38229 9
	308246B	24" x 100"	1	Roll	36.8	36.8	16	0 9971303272 9
	308248B	30" x 100"	1	Roll	45.8	45.8	16	0 9971303274 3
	308243B	36" x 100"	1	Roll	55.1	55.1	16	0 9971303269 9
	308244B	48" x 100"	1	Roll	73.4	73.4	16	0 9971303270 5
PVC Ctd - Green 19 gauge, 1/2" Mesh	308253B	24" x 5"	12	Roll	2.2	25.9	288	0 9971303193 7
	308254B	36" x 5"	12	Roll	3.4	41.3	192	0 9971303194 4
	308258B	24" x 25"	1	Roll	11.5	11.5	42	0 99713 38258 9
	308259B	36" x 25"	1	Roll	17.2	17.2	42	0 9971303277 4
	308260B	48" x 25"	1	Roll	22.9	22.9	42	0 9971303273 6

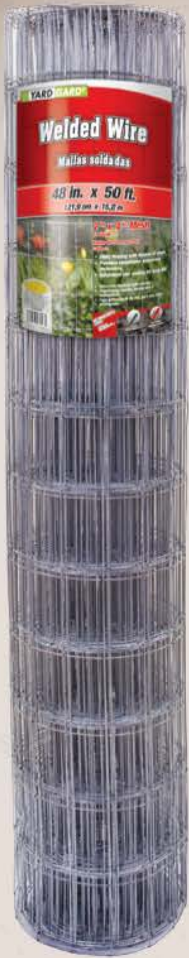

GALVANIZED WELDED WIRE

- Ideal for inexpensive temporary confinement applications
- A general purpose fence providing strength and stability
- Ideal for property delineation, confinement of non-aggressive animals, drain guards, fencing for backing split fence rail and more
- Class 1 galvanized zinc coating for long-life
- Available in 25', 50' and 100' rolls and 12 1/2, 14, and 16 gauges
- 2', 3', 4', 5', and 6' heights and variety of mesh sizes

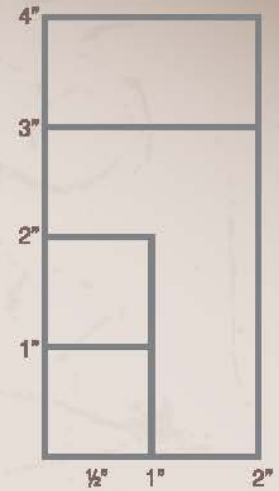

	MAT Item Number	Size	Master Pak Qty	UOM	Each Wt	Master Pak Wt	Pallet Qty	UPC Code Number
Galvanized,	309301A	24" x 25'	1	Roll	17.1	17.1	42	0 99713 39301 1
16 gauge, 1/2" x 1" Mesh	309303A	24" x 100'	1	Roll	68.4	68.4	9	0 99713 39303 5
	309306A	36" x 100'	1	Roll	102.3	102.3	9	0 99713 39306 6
	309304A	48" X 100'	1	Roll	136.2	136.2	9	0 99713 39304 2
Galvanized,	309312A	24" x 25'	1	Roll	13.2	13.2	42	0 99713 39312 7
16 gauge, 1" x 1" Mesh	309313A	24" x 100'	1	Roll	50.6	50.6	9	0 99713 39313 4
	309314A	36" x 100'	1	Roll	74.9	74.9	9	0 99713 39314 1
	309315A	48" X 100'	1	Roll	102.5	102.5	9	0 99713 39315 8
Galvanized,	309320A	24" x 25'	1	Roll	9.3	9.3	42	0 99713 39320 2
16 gauge, 1" x 2" Mesh								
Galvanized,	309213A	36" x 100'	1	Roll	105.0	105.0	9	0 99713 39213 7
14 gauge, 1" x 1" Mesh	309214A	48" x 100'	1	Roll	139.5	139.5	9	0 99713 39214 4
Galvanized,	309221A	24" x 25'	1	Roll	15.2	15.2	30	0 99713 39221 2
14 gauge, 1" x 2" Mesh	309222A	24" x 100'	1	Roll	55.1	55.1	9	0 99713 39222 9
	309223A	36" x 100'	1	Roll	82.3	82.3	9	0 99713 39223 6
	309224A	48" X 100'	1	Roll	109.6	109.6	9	0 99713 39224 3
	309226A	60" x 100'	1	Roll	137.0	137.0	9	0 99713 39226 7
	309225A	72" X 100'	1	Roll	164.2	164.2	9	0 99713 39225 0
Galvanized,	308301B	36" x 50'	1	Roll	20.5	20.5	20	0 99713 03126 5
14 gauge, 2" x 4" Mesh	308302B	48" x 50'	1	Roll	27.3	27.3	20	0 99713 03127 2
	308303B	60" x 50'	1	Roll	33.9	33.9	20	0 99713 03128 9
	308304B	72" X 50'	1	Roll	40.9	40.9	20	0 99713 03129 6
	308311B	36" x 100'	1	Roll	41.1	41.1	9	0 99713 03130 2
	308312B	48" X 100'	1	Roll	54.5	54.5	9	0 99713 03131 9
	308313B	60" x 100'	1	Roll	67.9	67.9	9	0 99713 03132 6
	308314B	72" X 100'	1	Roll	80.2	80.2	9	0 99713 03133 3
Galvanized,	308331A	36" x 50'	1	Roll	36.3	36.3	16	0 99713 38331 9
12.5 gauge, 2" x 4" Mesh	308332A	48" x 50'	1	Roll	48.4	48.4	16	0 99713 38332 6
	308333A	60" x 50'	1	Roll	60.6	60.6	16	0 99713 38333 3
	308334A	72" X 50'	1	Roll	72.7	72.7	16	0 99713 38334 0
	308321A	36" x 100'	1	Roll	70.3	70.3	9	0 99713 38321 0
	308322A	48" X 100'	1	Roll	92.3	92.3	9	0 99713 38322 7
	308323A	60" x 100'	1	Roll	114.7	114.7	9	0 99713 38323 4
	308324A	72" X 100'	1	Roll	138.0	138.0	9	0 99713 38324 1



PVC WELDED WIRE

- All the benefits of welded wire but coated to enhance longevity and appearance
- Adds a rich look by complimenting natural surroundings
- A versatile, lighter weight and economical solution to ornamental fencing

- Virtually maintenance free
- Uniformly galvanized prior to coating for reinforced rust and wear protection
- Available in 2" x 4" mesh, and 2" x 3" mesh

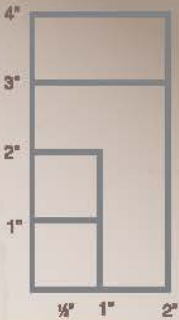

MAT Item Number	Size	Master Pak Qty	UOM	Each Wt	Master Pak Wt	Pallet Qty	UPC Code Number
GREEN							
308357A	36" x 50'	1	Roll	16.9	16.9	20	0 99713 38357 9
308358A	48" x 50'	1	Roll	22.5	22.5	20	0 99713 38358 6
16 gauge, 2" x 3" Mesh							
308350B	24" x 25' Jr. Roll	1	Roll	5.9	5.9	42	0 99713 03134 0
308349A	24" x 50'	1	Roll	13.2	13.2	36	0 99713 38349 4
308351B	36" x 50'	1	Roll	17.6	17.6	36	0 99713 03135 7
308352B	48" x 50'	1	Roll	28.7	28.7	36	0 99713 03136 4
308354B	60" x 50'	1	Roll	28.0	28.0	X	0 997130313 7 1
BLACK							
308381B	36" x 50'	1	Roll	20.9	20.9	20	0 99713 03136 7
308382B	48" x 50'	1	Roll	28.7	28.7	20	0 99713 03165 4



ECONOMY FENCE (WELDED WIRE)

- An economical option for home and garden applications
- Ideal for fencing vegetable and flower gardens, making compost bins, protecting seedlings, and backing for post

- and rail fencing
- 16 gauge
- 2" x 3" mesh

MAT Item Number	Size	Master Pak Qty	UOM	Each Wt	Master Pak Wt	Pallet Qty	UPC Code Number
308361B	36" x 50'	1	Roll	15.1	15.1	36	0 99713 03141 8
308362B	48" x 50'	1	Roll	20.0	20.0	36	0 99713 03142 5



TOMATO FENCE

- Sturdy galvanized wire keeps tomato plants upright while keeping some animals out
- Large mesh design makes tomato picking easy

- 4" x 6" mesh
- 16 gauge wire for strength

MAT Item Number	Size	Master Pak Qty	UOM	Each Wt	Master Pak Wt	Pallet Qty	UPC Code Number
901288A	48" x 20'	1	Roll	5.7	5.7	56	0 99713 91288 5



GARDEN FENCE (RABBIT FENCE)

- Specifically designed to keep out rabbits and other nuisance varmints
- Horizontal wire spacing gets progressively closer near the ground where protection is needed most (4-2-1 in.)
- Upper horizontal wire spacing allows hands to pass through
- This lightweight galvanized wire is an excellent temporary barrier around trees, bushes and flowers
- Vinyl coated option blends more naturally into surroundings

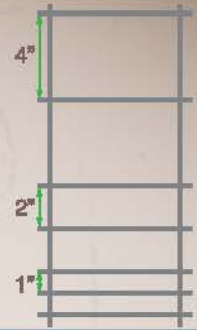

	MAT Item Number	Size	Master Pak Qty	UOM	Each Wt	Master Pak Wt	Pallet Qty	UPC Code Number
Galvanized, 14 gauge	308374A	28" x 25'	1	Roll	6.6	6.6	72	0 99713 38374 6
	308371B	28" x 50'	1	Roll	12.7	12.7	42	0 99713 03138 8
	308372A	40" x 50'	1	Roll	16.1	16.1	42	0 99713 38372 2
Vinyl Ctd Green, 16 gauge	308376B	28" x 50'	1	Roll	16.5	16.5	25	0 99713 03139 5



RABBIT NETTING

- Effective protection against grazing rabbits
- Similar to poultry netting with added horizontal wire strand for protection
- Hexagonal design as recommended by Forestry Commission
- Can also be used for rabbit hutches or chicken runs

MAT Item Number	Size	Master Pak Qty	UOM	Each Wt	Master Pak Wt	Pallet Qty	UPC Code Number
308481B	28" x 25'	12	Roll	3.9	37	144	0 99713 38481 1



CAGE WIRE

- Great for pet cages, rabbit hutches, plant holders and window well screens
- High quality, galvanized steel, with welded cross wires for added strength
- Made of 16-Gauge galvanized steel

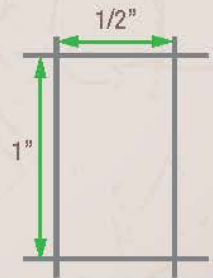

MAT Item Number	Size	Master Pak Qty	UOM	Each Wt	Master Pak Wt	Pallet Qty	UPC Code Number
309302A	30" x 10'	6	Roll	8.8 lb	6	90	099713033436
309312A	36" x 25'	6	Roll	13.1	36	36	099713033443
309311A	24" x 15'	6	Roll	7.6	6	144	099713033429



POULTRY NETTING

A favorite of farmers, pet owners and gardeners, and recognized by its trademark hexagon mesh weave. An economical, lightweight netting often used in pens to confine poultry, rabbits and other small animals.

- Other popular uses include plant protection and support, soil erosion prevention and compost pile confinement
- Made of strong but surprisingly flexible 20 gauge steel
- Galvanized prior to weaving for longer-lasting rust protection
- Each roll individually shrink-wrapped for product protection
- PVC option enhances product longevity and appearance

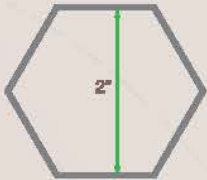

MAT Item Number	Size	Master Pak Qty	UOM	Each Wt	Master Pak Wt	Pallet Qty	UPC Code Number
Galvanized, 20 gauge, 1" Mesh							
308400B	24" x 10"	12	Roll	1.6	19.6	360	0 99713 03228 6
308410B	36" x 10"	12	Roll	2.4	29.1	240	0 99713 03233 0
308420B	48" x 10"	12	Roll	3.2	38.4	180	0 99713 03238 5
308404B	24" x 25"	6	Roll	3.9	23.4	252	0 99713 03230 9
308405B	36" x 25"	6	Roll	5.8	34.8	144	0 99713 03231 6
308406B	48" x 25"	6	Roll	7.7	46.2	90	0 99713 03232 3
308407B	60" x 25"	1	Roll	9.5	9.5	66	0 99713 03278 1
308408B	72" x 25"	1	Roll	11.4	11.4	66	0 99713 03279 8
308415B	12" x 50"	2	Roll	4.0	4.0	240	0 99713 03236 1
308402B	18" x 50"	2	Roll	5.8	11.5	216	0 99713 03229 3
308411B	24" x 50"	2	Roll	8.0	16.0	120	0 99713 03234 7
308421B	36" x 50"	2	Roll	11.2	22.5	100	0 99713 03239 2
308431B	48" x 50"	2	Roll	15.2	30.3	64	0 99713 03241 5
308444B	60" x 50"	1	Roll	19.0	19.0	36	0 99713 03245 3
308447B	72" x 50"	1	Roll	22.7	22.7	28	0 99713 03246 0
308418B	12" x 150"	1	Roll	11.9	11.9	60	0 99713 03281 1
308419B	18" x 150"	1	Roll	17.2	17.2	42	0 99713 03237 8
308413B	24" x 150"	1	Roll	22.9	22.9	30	0 99713 03235 4
308427B	36" x 150"	1	Roll	33.4	33.4	21	0 99713 03240 8
308432B	48" x 150"	1	Roll	45.1	45.1	15	0 99713 03242 2
308434B	60" x 150"	1	Roll	56.4	56.4	15	0 99713 03243 9
308435B	72" x 150"	1	Roll	67.5	67.5	15	0 99713 03244 6
Galvanized, 20 gauge, 2" Mesh							
308464B	24" x 25"	12	Roll	1.7	20.9	360	0 99713 03250 7
308465B	36" x 25"	12	Roll	2.6	3.2	240	0 99713 03251 4
308466B	48" x 25"	12	Roll	3.5	41.8	144	0 99713 03252 1
308474B	24" x 50"	6	Roll	3.5	20.9	216	0 99713 03253 8
308475B	36" x 50"	6	Roll	5.2	31.2	144	0 99713 03254 5
308476B	48" x 50"	6	Roll	6.9	41.7	108	0 99713 03255 2
308478B	60" x 50"	1	Roll	8.9	8.9	66	0 99713 03256 9
308479B	72" x 50"	1	Roll	10.4	10.4	66	0 99713 03257 6
308493B	18" x 150"	1	Roll	7.8	7.8	90	0 99713 03258 3
308494B	24" x 150"	1	Roll	10.4	10.4	90	0 99713 03259 0
308495B	36" x 150"	1	Roll	15.4	15.4	45	0 99713 03260 6
308496B	48" x 150"	1	Roll	21.2	21.2	45	0 99713 03261 3
308497B	60" x 150"	1	Roll	26.0	26.0	28	0 99713 03262 0
308498B	72" x 150"	1	Roll	30.8	30.8	28	0 99713 03263 7
PVC Ctd Green, 20 gauge, 1" Mesh							
308452B	24" x 25"	6	Roll	5.1	30.7	180	0 99713 03227 9



PLASTIC PRODUCTS

Plastic fencing has unique advantages making it an ideal choice for select applications.

- Economical
- High visibility and landscape blending colors
- Lightweight for easier transport
- Easy installation and tear-down
- UV resistant
- Rust, rot and corrosion resistant
- Perfect for short-term applications



ORANGE



PLASTIC BARRIER FENCE

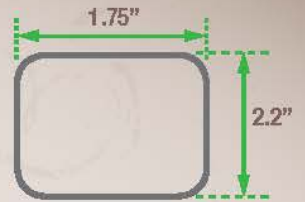

Provides a high visibility safety and warning system around construction sites, newly poured concrete or other potentially unsafe areas. Other uses include crowd control and property delineation.

MAT Item Number	Size	Master Pak Qty	UOM	Each Wt	Master Pak Wt	Pallet Qty	UPC Code Number
889210A	4' x 100'	1	Roll	8.3	398.4	48	0 99713 03201 9
889211A	4' x 50'	1	Roll	3.8	228	60	0 99713 03300 9

ORANGE



PLASTIC SNOW FENCE

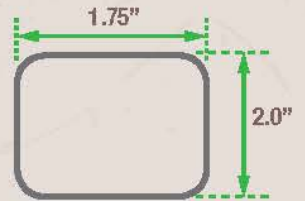

Offers effective snow drift control in parks, lots, along roads and other locations where snow control is needed. Installs easier than wood fencing.

MAT Item Number	Size	Master Pak Qty	UOM	Each Wt	Master Pak Wt	Pallet Qty	UPC Code Number
889220A	4' x 50'	1	Roll	11.8	708	60	0 99713 03202 6

BLACK



PLASTIC HARDWARE CLOTH

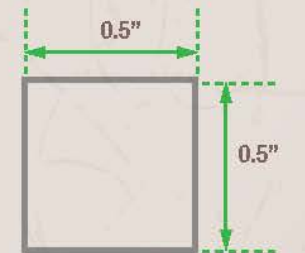

Dozens of screening and protective uses. Ideal for home, shop and garden.

MAT Item Number	Size	Master Pak Qty	UOM	Each Wt	Master Pak Wt	Pallet Qty	UPC Code Number
889230A	3' x 15'	12	Roll	3.5	42	72	0 99713 03203 3

GREEN OR BLACK



PLASTIC POULTRY NETTING

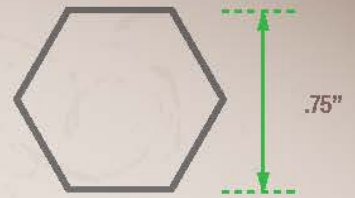

A favorite among farmers, gardeners and pet owners, poultry netting is recognized by its trademark hexagon weave. Use to construct pens for poultry, rabbits and other small animals. Other popular uses include support and protection for plants, shrubs and flowers.

MAT Item Number	Size	Master Pak Qty	UOM	Each Wt	Master Pak Wt	Pallet Qty	UPC Code Number
889240A	3' x 25'	9	Roll	4.6	41.4	54	0 99713 03204 0
889241A	3' x 25'	9	Roll	4.6	41.4	54	0 99713 03205 7

GREEN



PLASTIC GARDEN FENCE

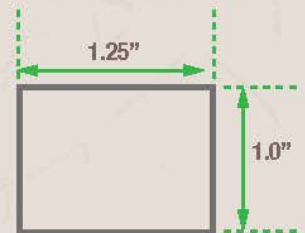

Ideal for protecting gardens and newly planted areas. Use it to surround compost piles and play and pet areas.

MAT Item Number	Size	Master Pak Qty	UOM	Each Wt	Master Pak Wt	Pallet Qty	UPC Code Number
889250A	40' x 25'	9	Roll	4.6	41.4	54	0 99713 03206 4
889241A	3' x 25'	9	Roll	4.6	41.4	54	0 99713 03205 7

BLACK



PLASTIC MULTI-PURPOSE NETTING



For a variety of applications that require stability, flexibility and visibility. Use with existing wooden fences for added security or to demarcate recreation and garden areas.

MAT Item Number	Size	Master Pak Qty	UOM	Each Wt	Master Pak Wt	Pallet Qty	UPC Code Number
889522A	2' x 25'	12	Roll	1.4	16.8	144	0 99713 02209 6
889523A	3' x 25'	12	Roll	2.1	25.2	72	0 99713 02210 2

BLACK



FOLDED DEER BLOCK NETTING

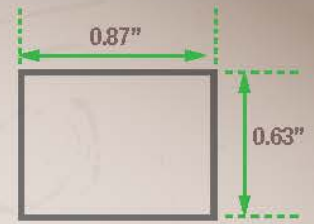

The perfect mid-grade perimeter netting. An excellent temporary deer deterrent.

MAT Item Number	Size	Master Pak Qty	UOM	Each Wt	Master Pak Wt	Pallet Qty	UPC Code Number
889553A	7' x 100'	20	Roll	8.5	170	20	0 99713 02212 6

BLACK



FOLDED DEER & BIRD NETTING



Protects fruits and vegetables from nuisance birds. Keeps pools and ponds leaf-free. Also discourages deer from damaging landscaping.

MAT Item Number	Size	Master Pak Qty	UOM	Each Wt	Master Pak Wt	Pallet Qty	UPC Code Number
889554A	7' x 100'	15	Roll	2.4	36	90	0 99713 02213 3

BLACK



PLASTIC SILT FENCE

Contractor-grade silt fence is one of the most economical and effective "temporary" sediment control devices available today. Installs quickly when short notice is given. Best utilized for open construction and residential development sites. Helps contractors meet health, safety and environmental mandates at construction sites.

MAT Item Number	Size	Master Pak Qty	UOM	Each Wt	Master Pak Wt	Pallet Qty	UPC Code Number
883121A	2' x 100'	1	Roll	18.0	18	25	0 99713 00945 5
883131A	3' x 100'	1	Roll	20.0	20	25	0 99713 00944 8

NOTE: POST are spaced every nine feet. Eleven posts per 100 foot roll.

MERCHANDISERS & PACKAGING



IN-AISLE FENCING SOLUTION CENTER*

- Products are kept neat and organized
- Hardware components adjust easily for regionally-targeted product assortments
- No wasted space. Simply expand or reduce display space according to seasonal needs
- Moves and sets up easily to accommodate floor plan changes
- Heavy-Duty steel components with durable white powder coat finish

* Gondola Not Included

- Includes eye-catching signage
- Ideal alternative to one-size-fits-all merchandising solutions
- Assembly instructions included

P-O-P & PACKAGING EASY-TO-OPEN BOX FOR QUICK SETUP!



WIRE FENCING • PLASTIC FENCING
CHAIN LINK • LAWN & GARDEN



6700 WILDLIFE WAY
LONG GROVE, IL 60047
PH: 1.800.628.8815